

Boynton Beach Turnpike Interchange Corridor

Design Guidelines & Standards for Future Development

**Palm Beach County, Florida
November 12, 1996
Revised 3/10/03**

**Prepared By:
Kilday and Associates
1551 Forum Place, Suite 100A
West Palm Beach, FL 33401
(561)689-5522 Fax (561)689-2592
File No. 707.26**

INTRODUCTION

The purpose of this manual is to encourage and provide uniform minimum standards for the design and implementation of future development along the Boynton Beach Turnpike Interchange Corridor.

- A. Effect of Interchange: The Florida's Turnpike Interchange is a major entrance to the area and will enhance this corridor as an economic activity area.
- B. Gateway to Boynton Beach: This corridor is the gateway to the West Boynton Community from all directions, but especially from the west.
- C. Neighborhood Plan: These design guidelines are consistent with the West Boynton Area Neighborhood Plan and further its goals.

This document is updated to allow for more flexibility in the application of the Guidelines to recognize the individuality of each project. These Guidelines have become an informal guide to development in the area of the West Boynton Area Community Plan (WBACP) and no longer specifically related to just six properties. It is the intent that these Guidelines will be used simultaneously for review of projects proposed within the area of the WBACP. This opportunity for flexibility in the application of these requirements is needed as they are utilized in conjunction with other Palm Beach County codes including the Unified Land Development Code (ULDC), Architectural Review and the Palm Beach County Security Code. The intent is for the Guidelines to be flexible in their application so that they are a "guide" to development, and are not meant to be taken verbatim if that application deviates from the other codes. Deviations from the recommendations of these guidelines is permitted if appropriate justification can be provided to show that the intent of the provision is being met, even if the design deviates from the actual written recommendation, and so long as the deviation exceeds the requirements or intent of the ULDC and Comprehensive Plan.

SECTION 1: PLANNING AREA AND OBJECTIVES

Planning Area

These design guidelines will apply to new construction or redevelopment of non-residential uses in the area generally included in the West Boynton Area Community Plan. These design guidelines utilize architectural standards already in place, including the Fountain of Boynton Beach Shopping Center.

Objectives

1. Provide guidelines for the enhancement and physical appearance of landscaping, architecture, signage and site development over and above the standards set by Palm Beach County, Florida for this corridor area.

2. Provide for the protection of property values of existing and future residents and landowners adjacent to the Boynton Beach Corridor.
3. Provide uniformity along Boynton Beach Boulevard to enhance the quality, relationship and consistency of future growth in this corridor.
4. Provide for and encourage the construction of pedestrian oriented facilities and universal accessibility.
5. Provide a planning tool for the design and development of future commercial properties to be used by the owners, developers and related professionals.
6. Provide guidelines to assist in the protection and health, safety and welfare of the public.

SECTION 2: BOYNTON BEACH BOULEVARD BUFFERS / STREETScape AND MEDIAN

- A. Boynton Beach Boulevard Buffer: The Boynton Beach Boulevard buffer is the most visible of all the planting areas. The landscaping and design of the buffer area should be simple, yet leave a strong impression of the character and quality of the development it represents. Because of its high visibility, it should be one of the most well designed and attractively landscaped areas. The Boynton Beach Boulevard buffer should be considered as important as, and an integral part of, the entrance area designs.

The landscape buffer along Boynton Beach Boulevard should be a minimum of 25 ft. in width and landscaped in accordance with the Palm Beach County guidelines, as well as the ones presented below. While detailed landscaping working drawings have not been prepared for this planting area, certain major guidelines have been developed to establish the criteria and basis upon which the working drawings can be prepared.

1. Trees and Palms: Live and Laurel Oaks shall be planted the entire length of frontage along Boynton Beach Boulevard within the back 15' of the buffer in two staggered rows. The spacing should be a maximum of 25' on center. Royal Palms shall be planted within the front 5' of the buffer, spaced 50' on center.
2. Shrubs and Ground Covers: Shrubs and ground covers shall be planted in masses under the canopy trees in a creative manner to give a staggered effect on hierarchy of plant material. Ixora 'Nora Grant' shall be planted in a bed at the base of each Royal Palm.

3. **Berms:** An undulating berm with a maximum height of 3' and a minimum height of 2' shall be provided in the buffer at a maximum slope of 4:1. Berm height should be measured from the elevation of the top of curb of the adjacent parking lot.

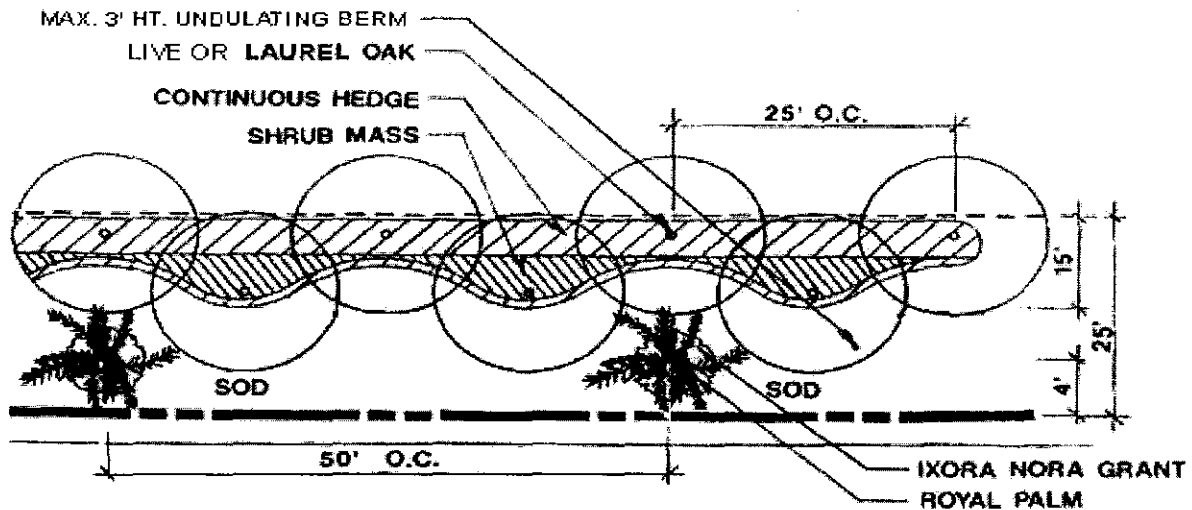

BOYNTON BEACH BLVD. LANDSCAPE BUFFER

- B. **Median Planting Within Boynton Beach Boulevard:** This should be landscaped in accordance with the Palm Beach County Streetscape guidelines and FDOT requirements, as well as the ones presented below. While detailed landscaping working drawings have not been prepared for this planting area, these guidelines have been developed to establish the criteria and basis upon which the working drawings can be prepared.

1. **Trees and Palms:** Laurel Oak Trees and Winin Palms of any caliper, as long as they can meet all the setback requirements, may be used within sight triangles. They shall be spaced no closer than 40' on center. Trees and palms with mature trunk calipers less than 4" can be planted 20' minimum, on center within sight triangles. Consideration for mature canopy and trunk caliper shall be taken into account when planting large shade trees and palms. This planting scheme will be repeated for the entire length of the median.
2. **Shrubs and Ground Covers:** Ground covers and shrubs shall be low growing, which at time of maturity will not exceed 30" in height or shall be varieties that can be appropriately maintained at 30" or less, within sight triangles. Grass mowing strips shall be a minimum width of 2' for maintenance of planting areas. This area will allow maintenance workers a

safe area in which to perform routine maintenance operations and shall be provided on the roadway side of all planting areas.

3. All plant material shall meet the specifications outlined in Section 3.

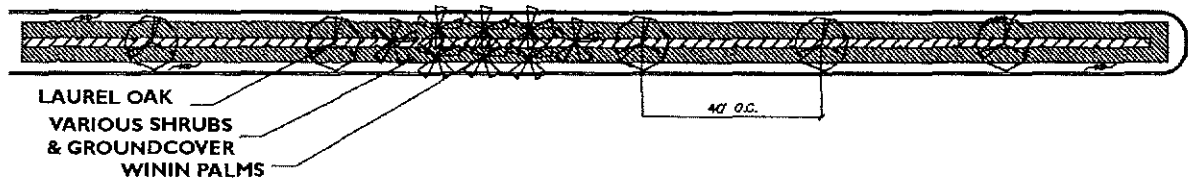

BOYNTON BEACH BLVD. MEDIAN LANDSCAPE

SECTION 3: LANDSCAPING GUIDELINES

- A. Main Entrance Landscape: A specific area at the entry to each commercial development will be established whereby a "main entrance" will be created. Within this planting area is the main entrance to the development. This entrance area should be the focal point of the Boynton Beach Boulevard streetscape and be clearly identified as the entrance to the project. The area within a 50' radius of the intersection of the right-of-way and entries into the project shall be restricted for the use of this "main entrance landscape."

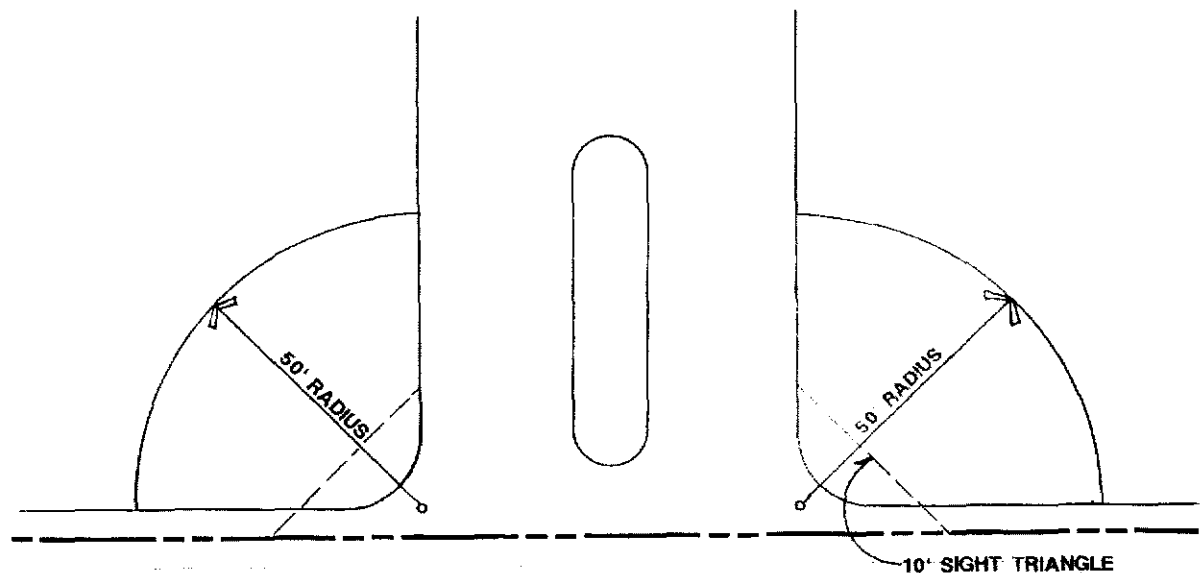

MAIN ENTRY LANDSCAPE AREA

A variety of landscape treatments should be developed in this planting area. Berming and clustering of plant materials, for example, are two techniques which could be used to enhance the visual quality of this focal point.

A ten (10') foot sight triangle shall be provided at the intersection of the right-of-way line and the project's entry.

Landscape Elements

1. **Berms:** Berms should be constructed within the entrance area and the maximum height should be 2.5 ft. above the elevation of the top of curb of the adjacent parking lot. The diameter should be the maximum permitted by the land configuration with a maximum slope of 4:1. The berm shall be designed to emphasize a sense of entry, but not interfere with the sight triangles.
2. **Trees and Palms:** Trees and palms should be planted in clusters along the slopes and crests of the berms. Some specimen trees and palms should be included in this planting area to provide either seasonal color or visual interest.
3. **Shrubs:** Shrubs should be planted in clusters along the slopes of berms. Shrubs should be 2' to 3' in height and 24" on center. Shrub plantings should also be designed to give a layering effect and a hierarchy of plant material.
4. **Ground Cover:** All areas not covered by trees or shrubs should be covered by recommended ground covers. Ground covers should be a combination of turf grass and low growing shrubs less than 1' in height.

B. Parking Area Landscape

In addition to Palm Beach County landscape requirements for parking areas, the following criteria must be met so that the landscaping can break-up large paving areas, and provide the maximum amount of shade for parking areas.

1. Large canopy shade trees shall be selected for all landscape island and medians located within parking areas. Large canopy trees can be substituted with a massing of three large palms.
2. Shrubs shall be planted along the entire length of all required divider landscape medians in the parking areas. Shrubs shall be 18" - 3' in height and planted 24" on center. The balance of these areas and the terminal islands shall be mulched or planted with ground covers other than sod.

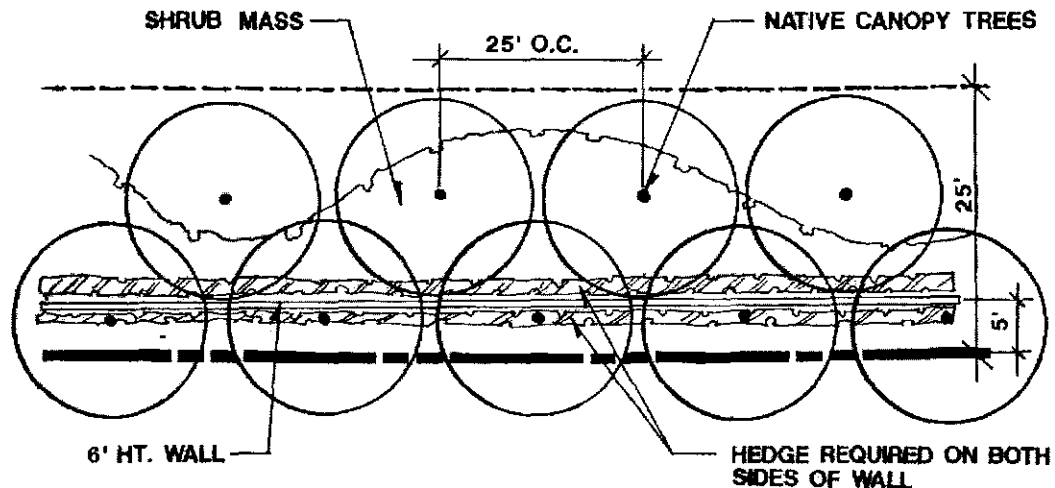

INTERIOR LANDSCAPE BUFFER

C. Interior Perimeter Landscape Buffers Shall Include:

1. A 6' height concrete masonry or panel wall and two rows of twelve to fourteen (12 - 14') feet tall shade trees planted a maximum of twenty (25') feet on center shall be required on both sides of the wall between non-residential and residential areas. Trees a maximum of twenty-five (25') feet on center between non-residential / non-residential or residential/residential areas shall be planted, but no wall is required by these guidelines.
2. Shrubs shall be planted on both sides of the wall along the entire length of all landscape buffers between non-residential and residential areas. Shrubs shall be 18" - 3' in height and planted 24" on center. A single hedge with shrubs 3' in height and planted 24" on center is required between non-residential / non-residential or residential / residential. The balance of these areas shall be planted with sod.

D. Right-of-Way Buffers Other than Boynton Beach Boulevard

1. Fourteen (14') feet tall shade tree planted a maximum of 15' feet on center shall be required. The buffer width shall be per code.
2. Shrubs shall be planted along the entire length of all required landscape buffers. Shrubs shall be 2' to 3' in height and planted 24" on center. The balance of these areas shall be planted with sod.

E. Preferred Plant Palette: A specific plant palette of acceptable landscape material and specifications is contained below. All landscape plans shall incorporate a minimum of 50% of materials specified in this palette. All new plant material shall

be Florida #1 or better according to the "Florida Grades and Standards for Nursery Plants", **Second Edition**.

LARGE TREES

Common Name / Botanical Name	Minimum Height	Drought Tolerant	Minimum Spread
GREEN BUTTONWOOD* Conocarpus erectus	12 – 14'	Very	6 - 7'
QUEEN'S CREPE MYRTLE Lagerstronemia speciosa	12 – 14'	Very	6 - 7'
LAUREL OAK* Quercus laurifolia	12 – 14'	Very	6 - 7'
LIVE OAK* Quercus virginiana	12 – 14'	Very	6 - 7'
MAHOGANY* Swietenia mahogany	12 – 14'	Very	6 - 7'
CHINESE ELM Ulmus parvifolia 'drake'	12 – 14'	Very	6 - 7'
PIGEON PLUM* Clusia diversifolia	12 – 14'	Very	6 - 7'
SEAGRAPE* Clusia uvifera	12 – 14'	Very	6 - 7'
DAHOON HOLLY Ilex cassine	12 – 14'	Very	6 - 7'
ROYAL POINCIANA Delonix regia	12 – 14'	Very	6 - 7'
SOUTHERN MAGNOLIA Magnolia grandiflora	12 – 14'	Very	6 - 7'

SMALL TREES

Common Name / Botanical Name	Minimum Height	Drought Tolerant	Minimum Spread
TREE LIGUSTRUM Ligustrum japonicum	10'	Very	5'
WAX MYRTLE* Myrica cerifera	10'	Very	5'
OLEANDER STANDARD Nerium oleander	10'	Very	5'
FRANGIPANI Plumeria acuminata	10'	Very	5'

LARGE PALMS

Common Name / Botanical Name	Minimum Height	Drought Tolerant
PAUROTIS PALM** <i>Acoelorrhaphe wrightii</i>	8'	Mod
ALEXANDER PALM** <i>Archonotophoenis alexandrae</i>	8'	Very
CHINESE FAN PALM** <i>Livistonia chinensis</i>	8'	Very
MEDJOOl DATE PALM** <i>Phoenix 'medjool'</i>	8'	Very
SENEGAL DATE PALM** <i>Phoenix reclinata</i>	8'	Very
SOLITAIR PALM** <i>Ptychosperma elegans</i>	8'	Very
ROYAL PALM** <i>Roystonea elata</i>	8'	Mod
SABAL PALM** <i>Sabal palmetto</i>	8'	Very
QUEEN PALM** <i>Syagrus romanzoffiana</i>	8'	Very
WININ PALM <i>Veitchia winin</i>	8'	Very

SMALL PALMS

Common Name / Botanical Name	Minimum Height ***	Drought Tolerant
PINDO PALM <i>Butia capitata</i>	10'-15'	Very
EUROPEAN FAN <i>Chamaerops humilis</i>	5'-10'	Low
SILVER PALM <i>Coccothrinax argentata</i>	10'-20'	Very
PYGMY DATE PALM <i>Phoenix roebellini</i>	5'	Mod
MAJESTY PALM <i>Ravenea glauca</i>	15'-20'	Low
NEEDLE PALM <i>Rhapidophyllum hystrix</i>	3'-5'	Mod
DWARF PALMETTO* <i>Sabal minor</i>	5'-7'	Very
SAW PALMETTO* <i>Serenoa repens</i>	6'-15'	Very
THATCH PALM* <i>Thrinax spp.</i>	15'-25'	Very

CHRISTMAS PALM Veitchii merrillii	15'-20'	Very
--------------------------------------	---------	------

SHRUBS

Common Name / Botanical Name	Drought Tolerant
WAX JASMINE Jasmine volubile	Mod
INDIAN HAWTHORNE Raphiolepis indica	Low
IXORA 'NORA GRANT' Ixora 'Nora Grant'	Very
CHALCAS EXOTICA Murraya paniculata	
PITOSPORUM Pittosporum tobira	Mod
PODOCARPUS Podocarpus nagi	Mod
YELLOW ALAMANDA Allamanda cathartica	Mod

GROUND COVERS

Common Name / Botanical Name	Drought Tolerant
BLUE DAZE Evolvulus glomerata	Mod
BUSH DAISY Gamolepis chrysanthemoides	Mod
DAYLILY Hemerocallis spp.	Very
DWARF YAUPON HOLLY Ilex vomitoria 'shillings'	Very
SHORE JUNIPER Juniperus conferta	Very
LIRIOPE Liriope muscari	Low
DWARF PITTOSPORUM Pittosporum 'wheelers dwarf'	Mod

* Denotes plants that are native to Florida

** Min. height denotes clear trunk

*** Min. height denotes overall height

SECTION 4: ARCHITECTURAL DESIGN GUIDELINES

The following recommendations apply to the architectural design of buildings. In the event of conflict between these guidelines and the ULDC Architectural Guidelines, the more restrictive requirements shall prevail.

- A. All structures within the Boynton Beach / Turnpike Corridor shall be constructed of the following exterior materials and incorporate the architectural design elements listed below.
1. Architectural style shall be of the Spanish Mission or Mediterranean type.
 2. Exterior finishes of stucco or similar finish, such as "EIFS/Dryvit", brick, coquina finish or finished cut stone, i.e., barrel or Spanish "S" tile, granite, limestone, travertine, and changes in color and stucco texture qualify as a means of providing visual interest to larger wall planes. The use of EIFS/Dryvit should be limited to those areas of the building above 7' in height.
 3. Decorative architectural elements, when used, of architectural cast stone, concrete or similar materials. "EIFS" or "Dryvit" systems or similar materials shall be limited to those areas of the building above 7' in height.
 4. Architectural accents of architectural metals (not including siding), wood, architectural cast stone, concrete, clay and ceramic tile, and awnings.
 5. Light and neutral building colors: white, off-white, cream, tan, grays, earth tones and pastels.
 6. Sloped roof forms including gable and hip roof treatment, or modified parapets to resemble a mansard roof form look.

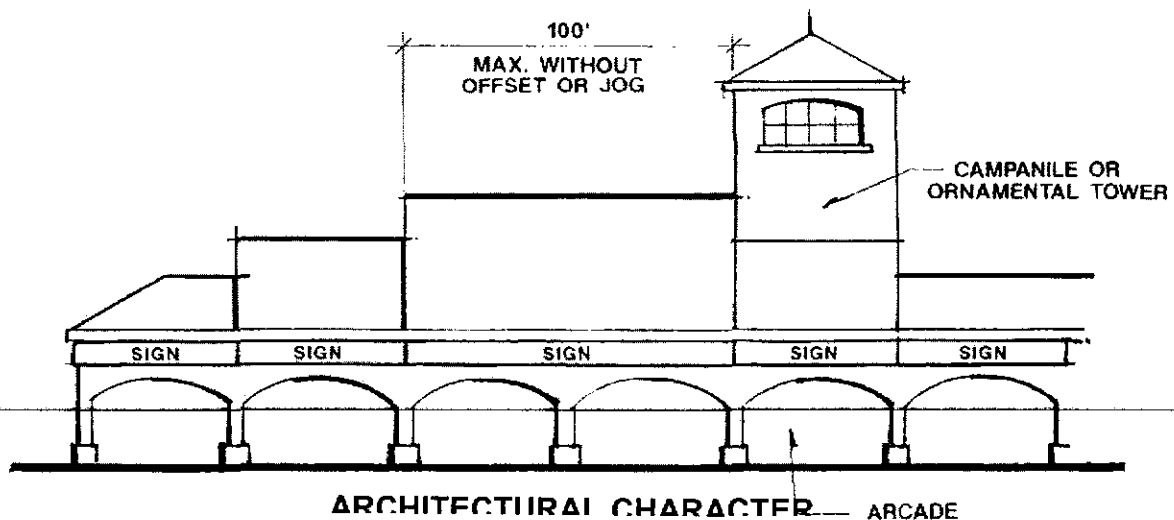

7. Roof lines shall not run continuously for more than one hundred (100') linear feet without offsetting or joggng the wall and roof planes.
8. The use of one or more of the following: arcades, colonnades, loggias, campaniles, substantially extended overhangs, canopies, ornamental and structural architectural details, arbors, trellises, gazebos, courtyards, ornamental and useable balconies with balustrades, columns, quoins, and finials are highly recommended. Their incorporation should be consistent with the scale and design of the building.
9. Pedestrian plazas with public amenities such as: flag poles, fountains, pavers, sculpture, benches, decorative light fixtures, trash receptacles, art /sculpture, and well designed gang distributor cabinets all coordinated with landscaping and lighting, are strongly encouraged.
10. Clear glass windows (88% light transmission or more). This does not preclude the use of mullions and muntins. Glazing style colors and tinting should be compatible with the material and color palette of the building.
11. Each project shall incorporate at least one major vertical accent element and one minor vertical element (i.e., bell tower, campanile, cupola, belvedere or other design element) of an appropriate size and proportion, to add visual interest and to establish an image and identity for the Boynton Beach Boulevard Turnpike Interchange Corridor. The number of vertical elements each project shall provide is based on the number of buildings on the site.

# of buildings	Major Vertical Element	Minor Vertical Element
1- 3	1	1
4-5	2	3
6-7	3	5
Above 7	1 per 3 buildings	2 per 3 buildings



VERTICAL ELEMENT GRAPHIC

12. All roofs on parcels abutting Boynton Beach Boulevard shall be terra cotta blend colored barrel tile.

SECTION 5: SIGNAGE GUIDELINES

In addition to any Palm Beach County Signage, regulations to the following guidelines will also be met to provide uniform appearance to Boynton Beach Boulevard. The signage system must be designed to create an image and identity for the commercial area which shall create an overall uniformity for the Boynton Beach Turnpike Interchange Image.

- A. Shopping Complex Identification Sign: This sign will be visible from major circulation corridors leading to the commercial area and will introduce the uses to that area. This sign will be of the monument type and will incorporate decorative walls utilizing architectural materials and or details of the building(s) on the site and contain only the name of the project.
 1. The use of solid stucco or similar material such as EIFS/Dryvit surface on the wall with architectural cast stone accents or EIFS details is strongly encouraged. The uses of EIFS/Dryvit should be limited to those areas of the sign where it is least likely to sustain damage.
 2. The maximum height shall be 10'.
 3. The maximum width of the sign face area shall be 15'.

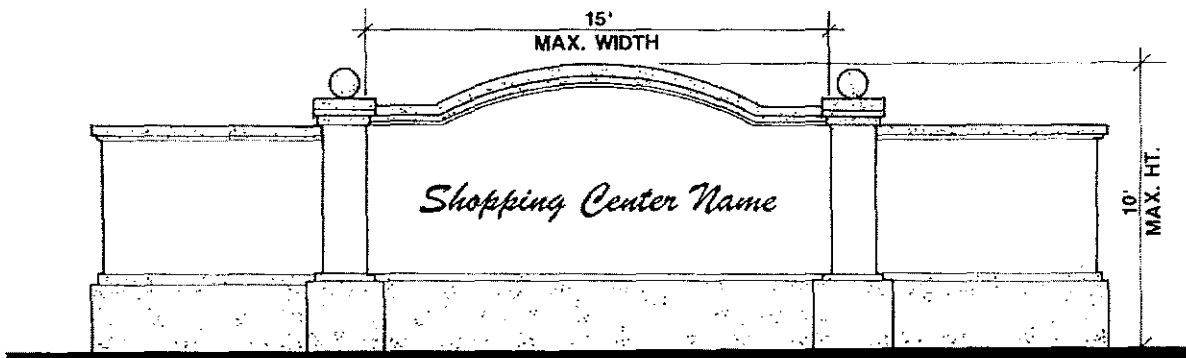

SHOPPING COMPLEX IDENTIFICATION SIGN

- B. Point of Purchase Sign: The largest standard sign and typeface will be the "Point of Purchase Sign" and shall be consistent with the style, detailing and colors of the architectural design of the project.
1. Maximum height shall be 12' for commercial parcels and 8' for commercial low office parcels.
 2. A maximum width shall be 12'.

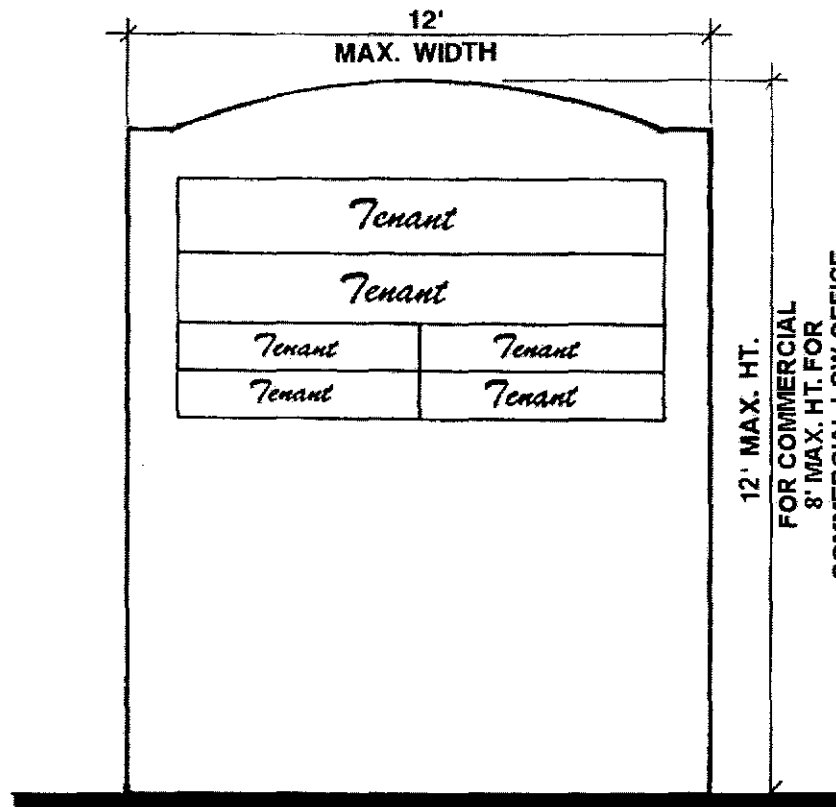

POINT OF PURCHASE SIGN

- C. Outparcel Identification Sign: The third standard sign and type face will be the "Outparcel Identification Sign." The sign shall only be used on outparcels when one individual building is used for one specific type use. It shall also be designed to compliment the architecture of that particular outparcel.
1. Maximum height shall be 6'.
 2. Maximum width shall be 10'.

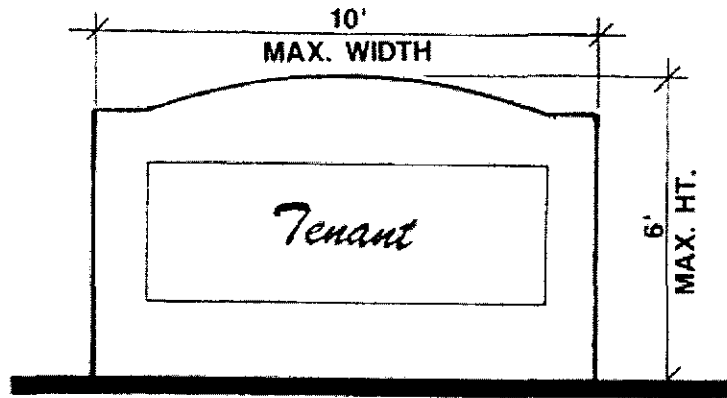

OUTPARCEL SIGN

D. Directional Signs: Directional Signs will also be incorporated into the site. They will give minor directional sequences to a specific type use. They shall also be designed to compliment the architecture.

1. Maximum height shall be 4'.
2. Maximum width shall be 3'.

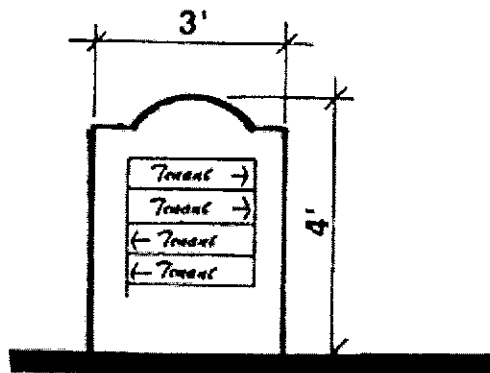

DIRECTIONAL SIGN

E. Individual Business Signs: Individual business signs shall be incorporated into architecture so that a uniform appearance to individual signs is accomplished.

1. Wall signage on buildings shall not be mounted higher than 20' in height.

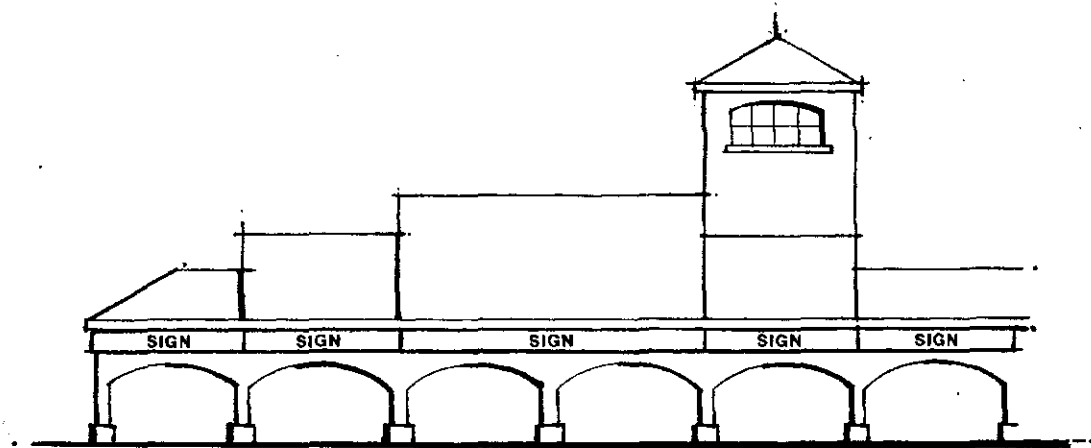

INDIVIDUAL BUSINESS SIGNAGE

- F. Sign Uniformity: The signage system must have a uniform system so that as store names change, or are added, the system can accommodate this without having a tacked-on or mismatched appearance.
- G. Additional Requirements
2. Main entry signage must be placed clear of required safe sight lines.
 3. Signs shall not be directly painted on any wall, roof, or other structural element of the building.
 4. Roof mounted signs are prohibited.
 5. All signage material and finishes must be durable to last through long term use. Concrete, metals, most plastics and fiberglass are considered durable signage materials.
 6. Signs must be monument-type, solid from the ground up. Pole signs are not permitted.
 7. Due to the change in grade along the Turnpike Interchange, the two parcels adjacent to Florida's Turnpike will be allowed one freestanding sign each along the Turnpike frontage up to a height of 35' measured from finished grade, to be located within 15' of the canal right-of-way line.
 8. Signage must be in scale with the building elements to which they are attached.
 9. No changeable text is allowed on point of purchase and outparcels signs, except for gas station pricing.

10. All monument signs shall be externally lit by wall or ground mounted lighting fixtures.
11. Signs on site shall be uniform as to font and color.

SECTION 6: LIGHTING

In the event of a conflict between these guidelines and the PBC Security Code, the more restrictive requirements shall prevail.

- A. Site lighting guidelines shall be used to provide a standard for illuminating the site as well as providing adequate security for the area.
 1. All free standing light fixtures shall be shielded and directed downward.
 2. Shielding shall be provided when abutting a residential area. No spillover at residential property line or right-of-way line.

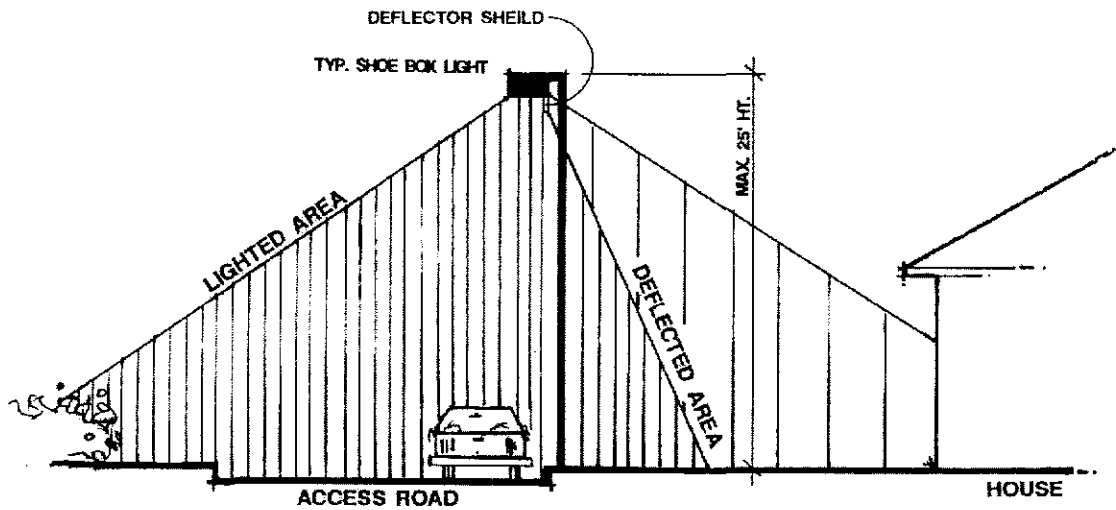

DEFLECTED LIGHTING

3. Maximum height of 25'.
4. Follow the following lighting levels:

		Minimum Foot Candles
a. <u>Pedestrian Areas</u>	Sidewalks/Pedestrian Ways	2.0
b. <u>Parking Areas</u>	Self Parking	1.0

	Attendant Parking	2.0
c. <u>Building Areas</u>	Entrance, Doorway Areas	5.0
	General Grounds	1.0

SECTION 7: GENERAL SITE DEVELOPMENT STANDARDS

The following general standards apply to all developments within the corridor.

- A. Entry Nodes: At all entries to developments that connect to the Boynton Beach Boulevard right-of-way, a formal entry design theme will be implemented. It will be in the form of a "Shopping Complex Identification Sign" (Section 5). Landscaping (Section 4), center islands and decorative paving patterns will be utilized to delineate the transition from the public right-of-way to private property. These paving patterns should clearly mark elements such as stop bars, pedestrian cross walks and traffic circulation.

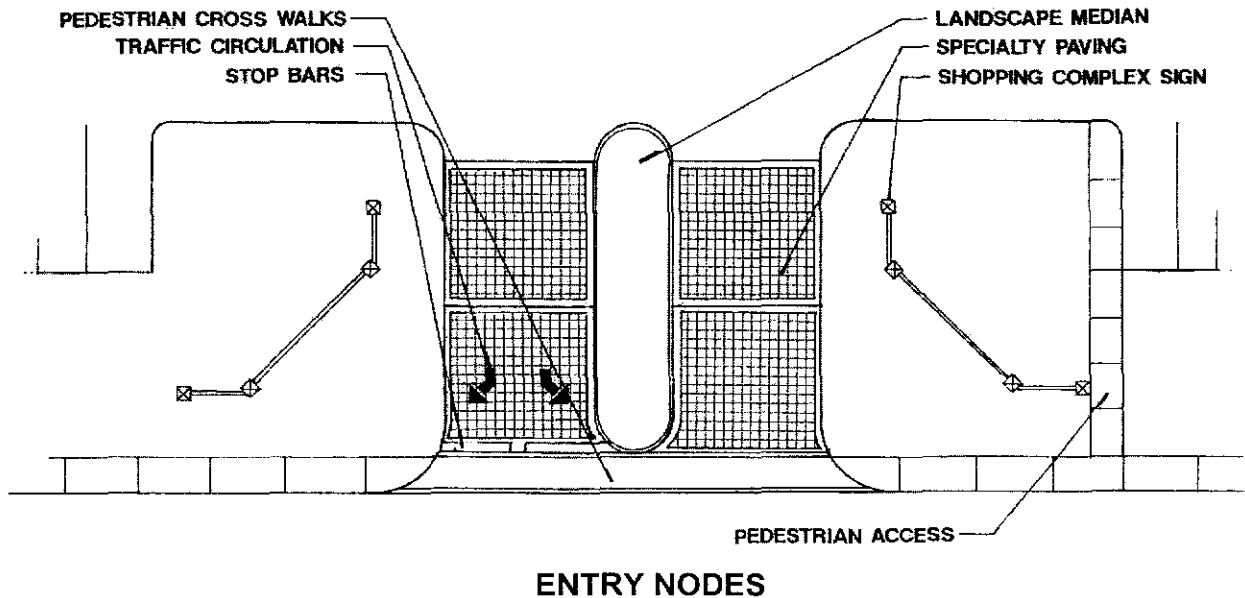

- B. Screening of Residential Zoning Districts: Commercial sites abutting a residential zoning district shall provide screening. Screening shall consist of the following: an opaque concrete, masonry or panel wall consistent with the architectural design of the project of six feet in height (walls directly adjacent to the required buffer shall be credited towards this requirement); a buffer area width of at least twenty-five feet, including the required opaque wall; and

landscaping. Landscaping shall consist of shade trees, ground cover, grass, hedges and shrubs. Landscaping must be provided on both sides of the required screening wall. However, if landscaping is provided in this manner, the wall shall be located at least five feet from the property line in order to allow for accessibility for maintenance. Specifications for landscaping are provided in Section 3C.

- C. Pedestrian Entrances: To the extent feasible, consistent with the design and intended use of a commercial structure, major public entrances shall be located along Boynton Beach Boulevard. In the event a commercial structure is located on property that does not possess frontage along Boynton Beach Boulevard, public entrances shall be located along the street providing principal vehicular access.
1. A clearly designated pedestrian walkway shall be provided from public sidewalks to public entrances or walkways within a commercial site.
 2. To the extent feasible, pedestrian circulation shall be provided between abutting commercial properties through the use of designated walkways and similar pedestrian-oriented facilities. Designated pedestrian walkways allowing access to a commercial site for residents of abutting residential zoning districts shall be provided; however, such walkways shall be provided only to the extent feasible where desired by the adjacent property owners.
- D. Pedestrian Waiting Areas: A minimum of one pedestrian waiting area shall be located within 300' of any building entry and shall be separate from walkway thoroughfares. Adequate shelter, seating and lighting should be provided
- E. Drop off Zones: Shall be located as close to the main building entry as possible to provide direct vehicular connections between the site entry, parking and circulation. There shall be an area where no change in grade between roadway and the adjacent walkway is provided for barrier free access.
- F. Sidewalks: Sidewalks of concrete, stamped concrete or decorative pavers shall be installed along all portions of the site abutting a public right-of-way. Sidewalks to be constructed as part of any road expansion or improvement plan shall be credited towards this requirement.
- G. Sight Triangle or Corner Clip: Sight distance triangles or corner clips shall be provided in accordance with the Country Design Manual, published by the Department of Engineering, to restrict placement of visual obstructions.

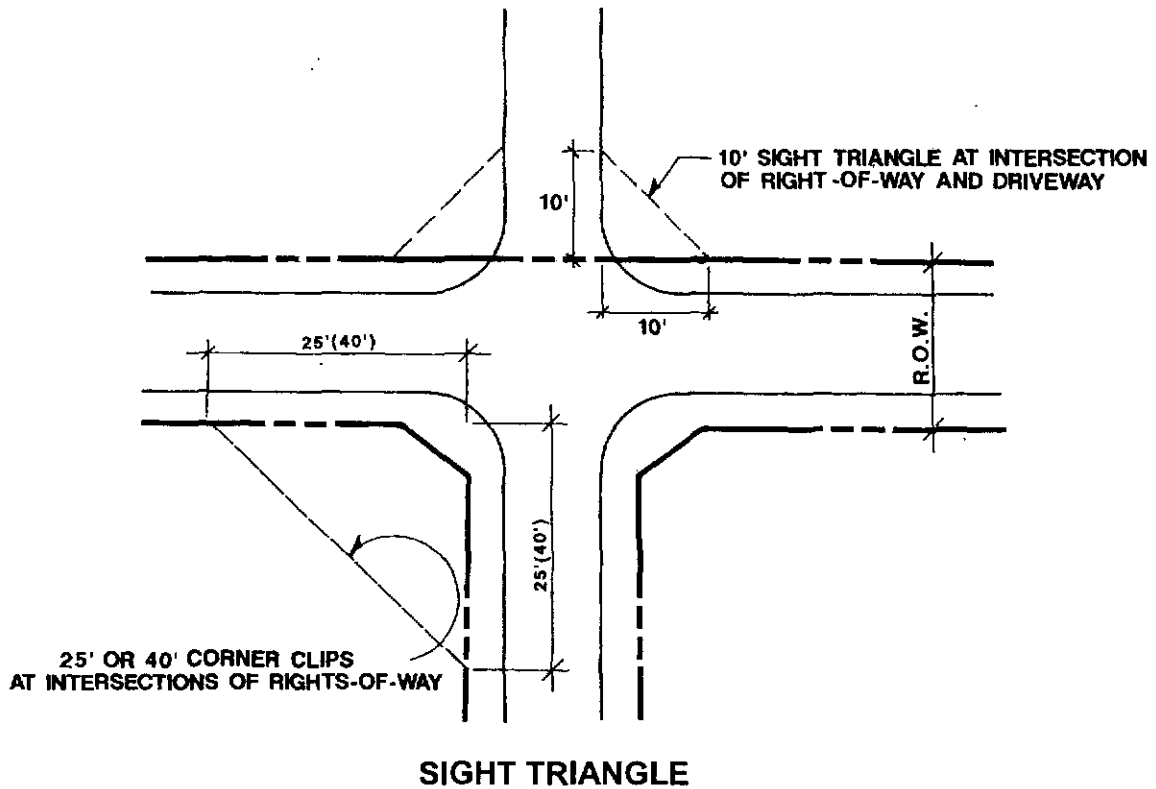

- H. Screening of Mechanical Equipment. All mechanical equipment shall be screened from public view. Such screening may include any combination of landscaping and opaque materials. If building materials are to be utilized for screening purposes, such materials shall be consistent with the architectural materials of the principal structure. At installation, screening shall extend at least one foot above the object to be screened.
- I. Screening of Solid Waste Disposal Facilities. Dumpsters, trash compactors and similar facilities shall be screened on all four sides from public view. Both sides and the rear of such facilities shall be screened by an opaque concrete or panel wall or similar material consistent with the architectural design of the project. The front of a screen enclosure shall be gated and shall consist of durable materials consistent with the overall design of the project. Landscaping shall also be required in addition to opaque screening material. All landscaping and materials utilized to screen an enclosure shall be consistent with the overall design of the principal structures located on the site.
- J. Storage Areas: All storage areas shall be screened from public rights-of-way and from adjacent residential zoning districts. Screening enclosures may consist of any combination of landscaping, fencing and opaque building materials. If building materials are to be utilized for screening purposes, such materials shall be consistent with the architectural material of the principal structures.

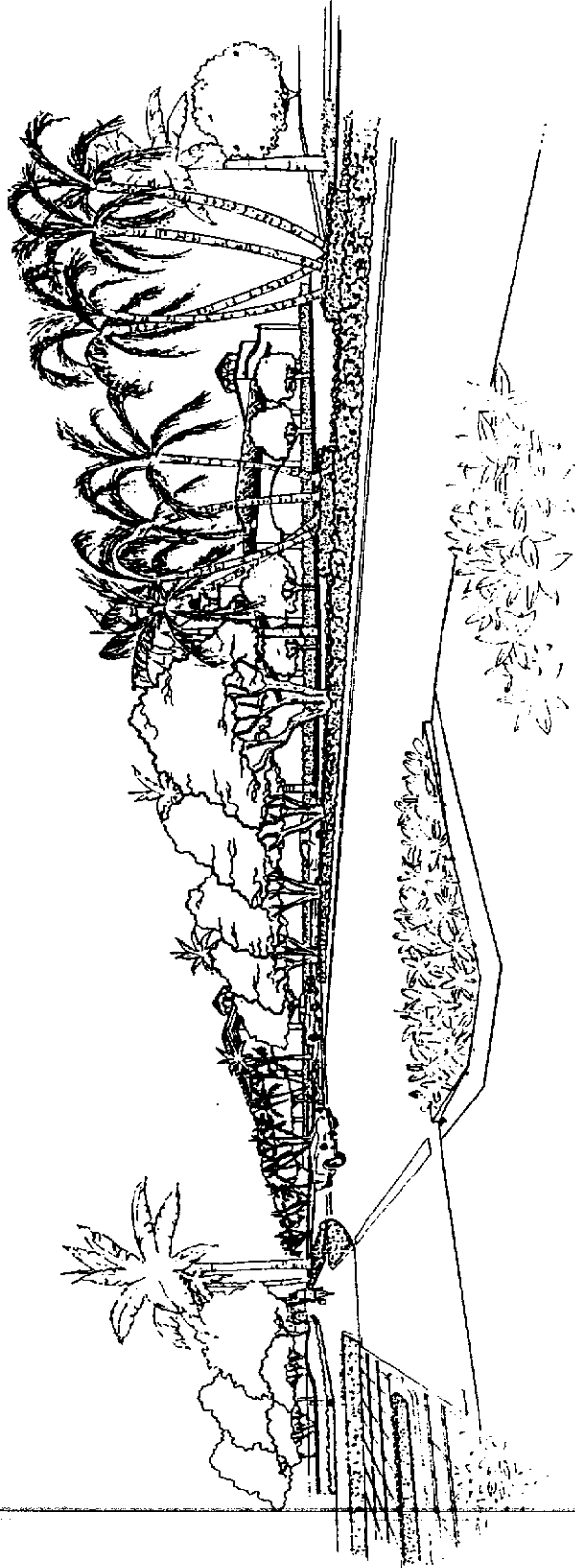

BOYNTON BEACH BLVD. STREETSCAPE

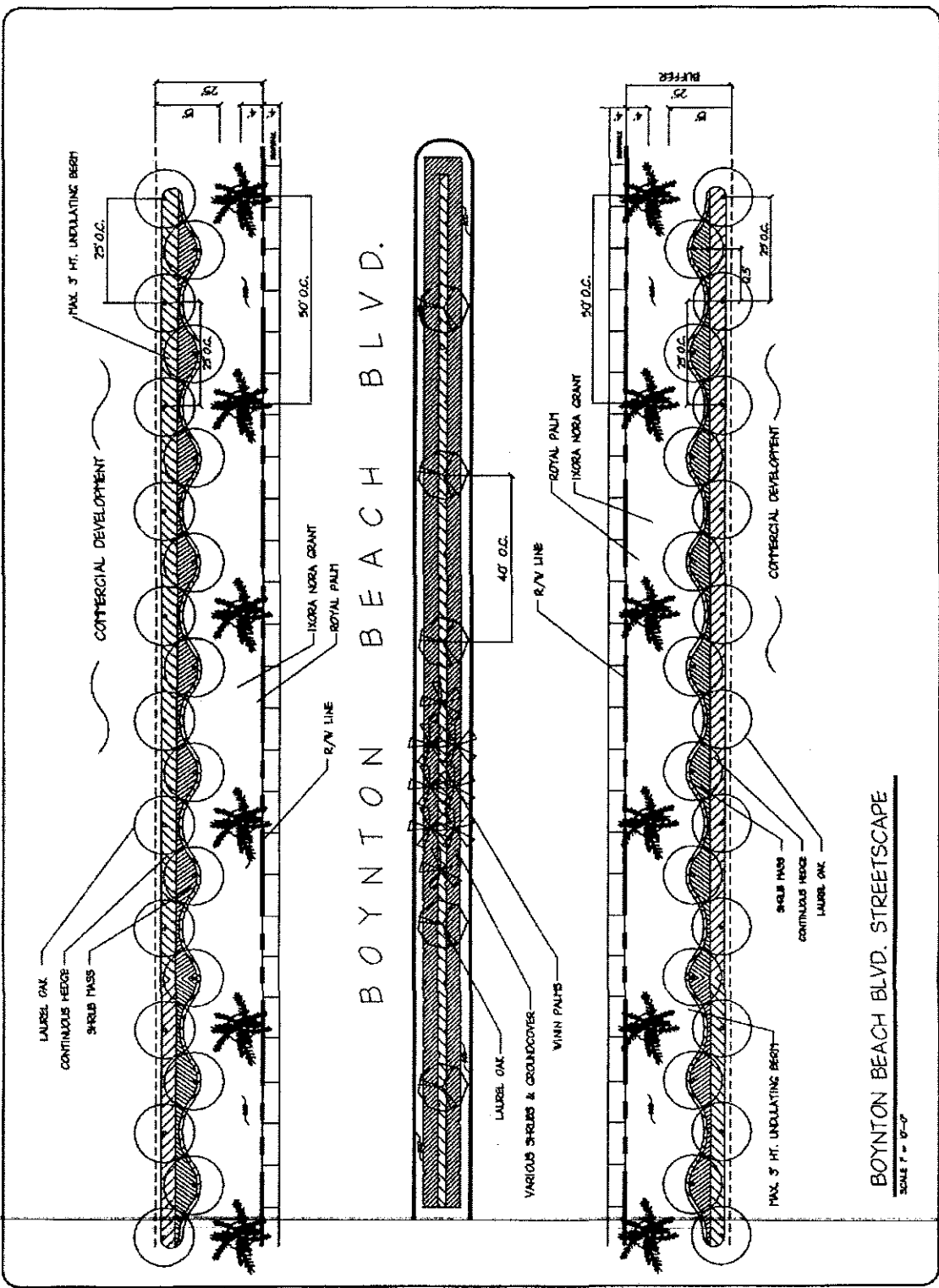

Boynton Beach Turnpike Interchange Corridor

Palm Beach County, Florida
BOYNTON BEACH BOULEVARD STREETSCAPE

KIDDY & ASSOCIATES
Landscape Architects/Planners
1551 Form Place
Suite 100A
West Palm Beach, Florida 33411
(407) 689-5522 Fax: (407) 689-2592

Scale: As Shown
Date: 3/10/03
Drawn by: L.S.
File No: BBE-03-13
Drawing No: 707.26
Project: Palm L. Turnpike Interchange Corridor
Sheet 1 of 1

